

SUPPLY & EXTRACT AIR VALVE

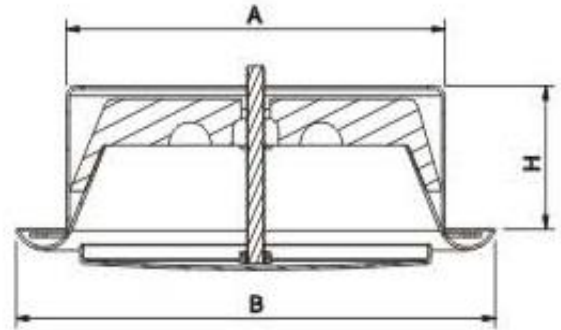

Description: Steel air supply and exhaust valves with adjustable core and 42mm mounting frame. Wall or ceiling mounted valves are used for air supply and exhaust inside buildings.

Features:

- Materials: Steel.
- Construction: Pressed steel grille with adjustable core with galvanised steel mounting.
- Mounting: Fixing in the mounting frame.
- Colour: RAL 9010 (Standard) other RAL colours available on request.

We now also stock in RAL9016

Supply & Extract Air Valve					
Item #	Type	Size	Neck (A)	Face (B)	Height (H)
237210	Supply	100mm	98mm	150mm	42mm
237210E	Extract	100mm	98mm	150mm	42mm
237212	Supply	125mm	123mm	175mm	42mm
237212E	Extract	125mm	123mm	175mm	42mm
237215	Supply	150mm	148mm	200mm	42mm
237215E	Extract	150mm	148mm	200mm	42mm
237216	Supply	160mm	159mm	210mm	42mm
237216E	Extract	160mm	159mm	210mm	42mm
237220	Supply	200mm	198mm	250mm	42mm
237220E	Extract	200mm	198mm	250mm	42mm

POLYAIRE UK
Units 3 & 4, Torridge Close,
Telford Way Business Park,
Kettering, Northants,
ENGLAND, NN16 8PY
Telephone: 01536 519922
sales@polyaire.co.uk

Performance Data – Supply Valve

Key: The blue line indicates terminal velocity of 0.2m/s. The corresponding number is the adjustable core position in mm

Noise Reduction

100mm

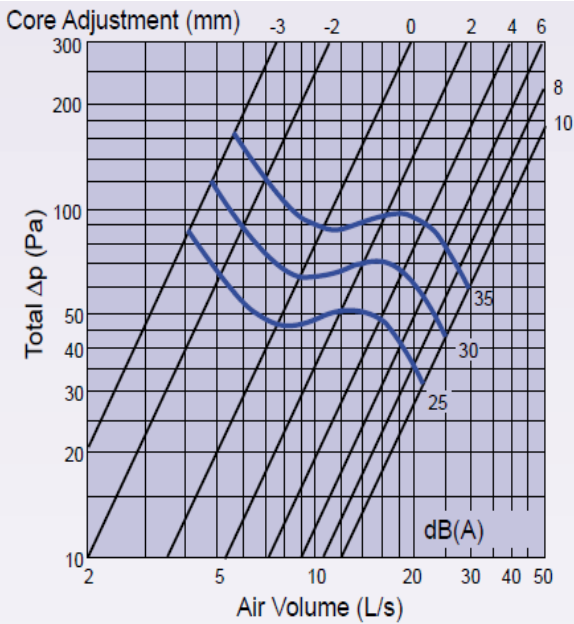

Throw

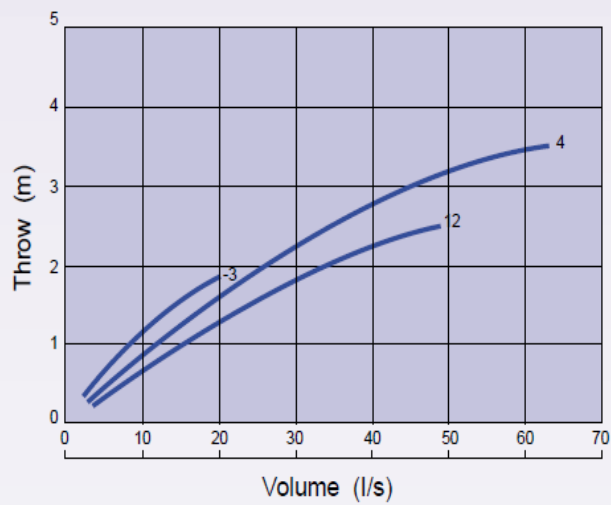

125mm

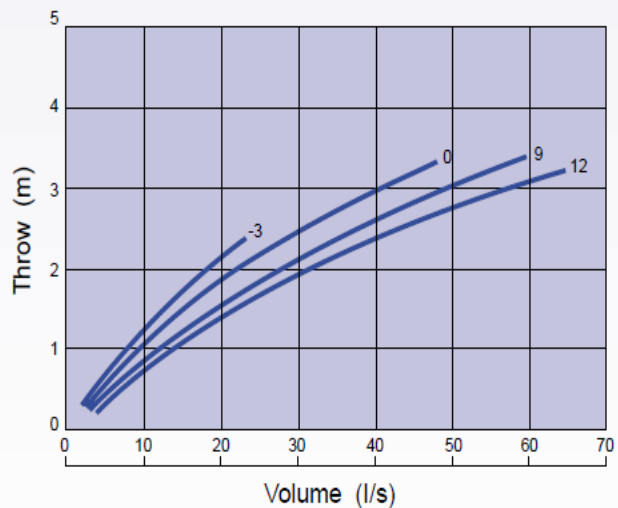
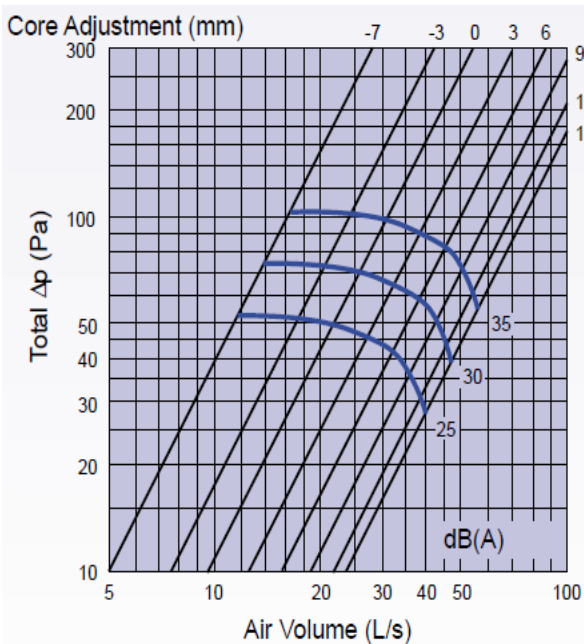

150mm

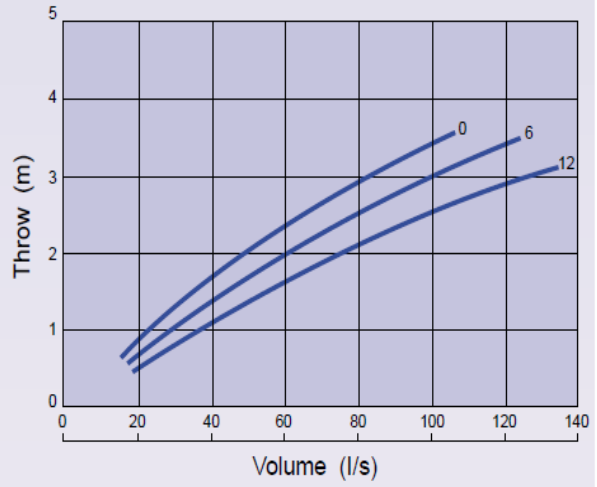
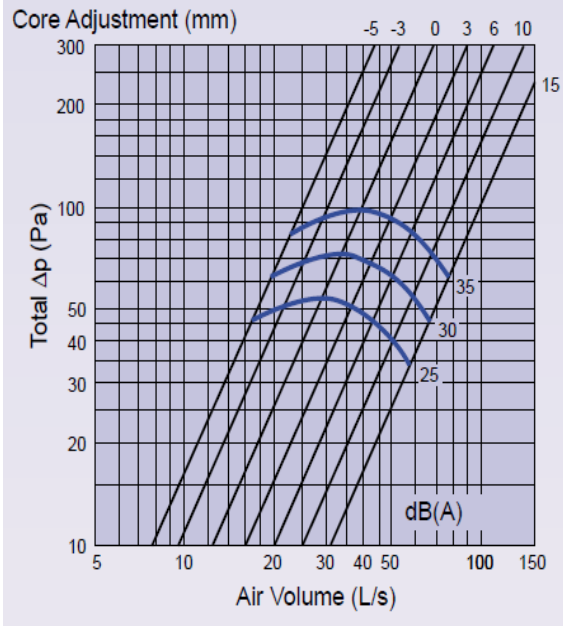

160mm

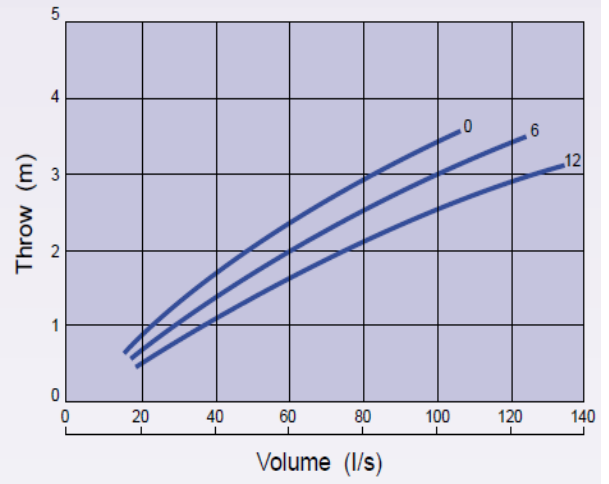
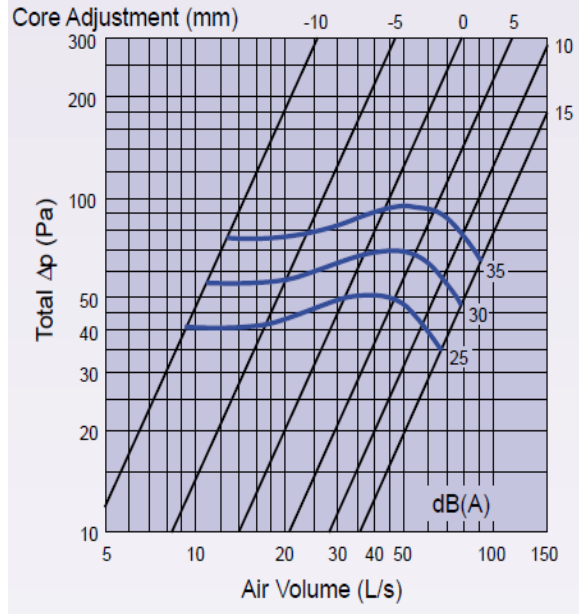

200mm

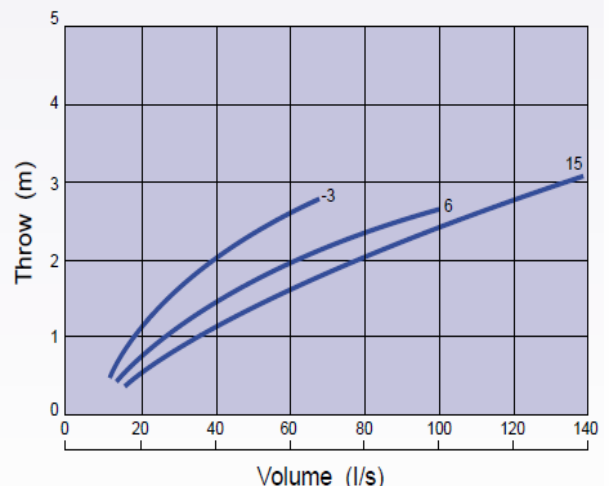
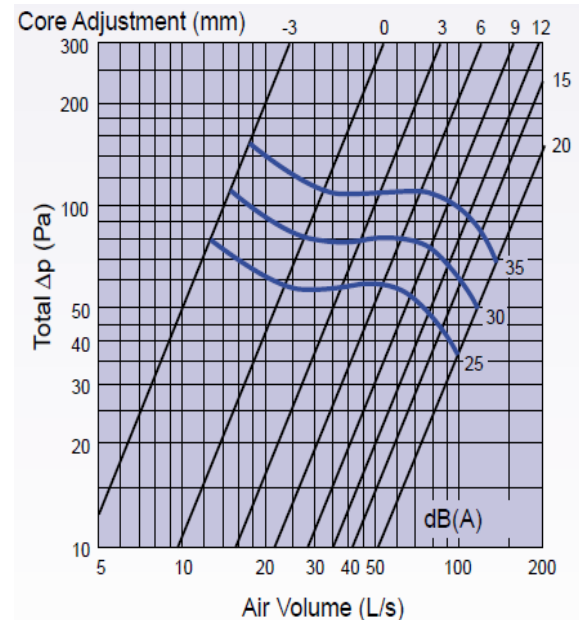

Performance Date – Extract Valve

100mm

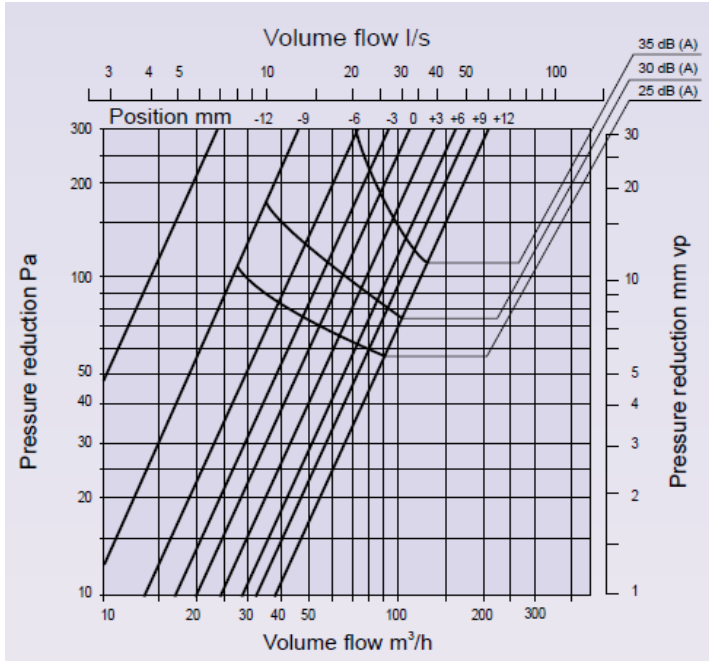

125mm

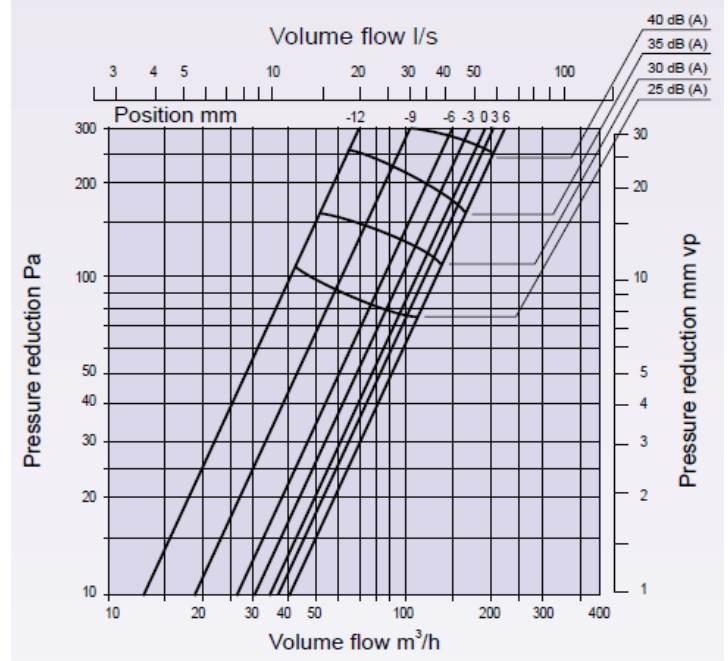

150mm & 160mm

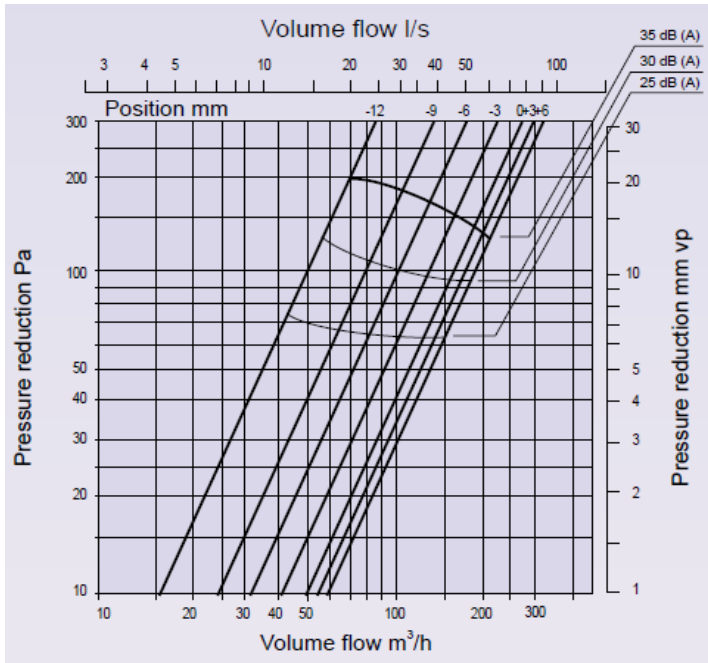

200mm

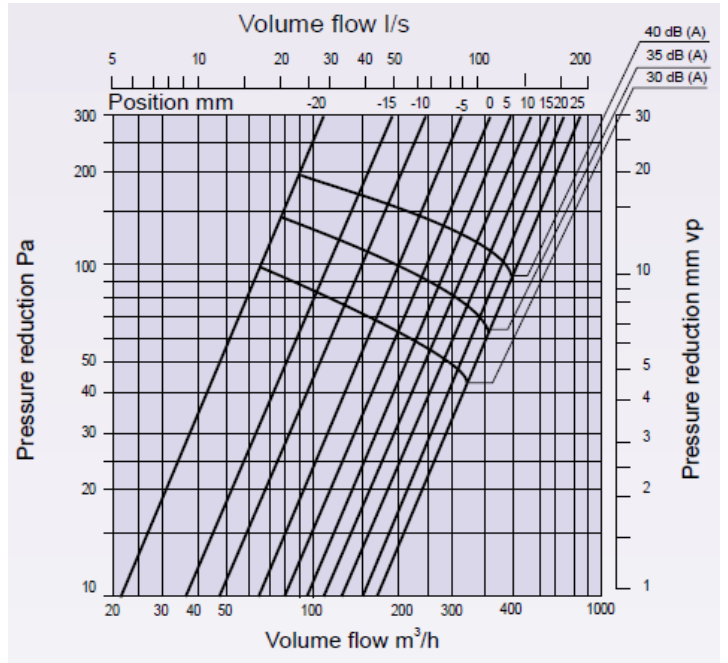

POLYAIRE UK

Units 3 & 4, Torridge Close,
Telford Way Business Park,
Kettering, Northants,
ENGLAND, NN16 8PY
Telephone: 01536 519922
sales@polyaire.co.uk